

HallinSight®

Magnetic Measurement System

INSTRUCTION MANUAL

Requirements, Software Installation and
Operation, Technical Specifications

Authors:

Dr. Philip Beran

Fraunhofer Institute for Integrated Circuits

Version 4.3

Version	Date	Changes
3.0	2019-12-12	Initial Version
3.1	2020-04-02	New Features Added
4.0	2021-08-01	More Sensor Modules Added
4.2	2022-05-10	New Hardware and Transient Mode Added
4.3	2022-08-19	16x16 Pixel Plane Array Added

Version History

1	BASIC INFORMATION	4
1.1	SYSTEM REQUIREMENTS.....	4
1.2	OPERATING CONDITIONS.....	4
1.3	CUSTOMER SUPPORT.....	4
2	SOFTWARE DESCRIPTION	5
2.1	SOFTWARE INSTALLATION.....	5
2.1.1	<i>USB Driver Installation</i>	<i>5</i>
2.1.2	<i>GUI Software Installation.....</i>	<i>5</i>
2.2	SOFTWARE START	5
2.3	GUI SOFTWARE.....	6
2.3.1	<i>General Information.....</i>	<i>6</i>
2.3.2	<i>Context Help.....</i>	<i>6</i>
2.3.3	<i>GUI header.....</i>	<i>7</i>
2.3.4	<i>Measurement.....</i>	<i>8</i>
2.3.5	<i>Calculation</i>	<i>9</i>
2.3.6	<i>3D Vector Plot</i>	<i>10</i>
2.3.7	<i>3D Surface Plot.....</i>	<i>11</i>
2.3.8	<i>2D Surface Plot.....</i>	<i>12</i>
2.3.9	<i>2D Contour Plot.....</i>	<i>13</i>
2.3.10	<i>2D Arrow Plot.....</i>	<i>14</i>
2.3.11	<i>Section Graphs</i>	<i>15</i>
2.3.12	<i>Data Logging.....</i>	<i>16</i>
2.3.13	<i>Advanced.....</i>	<i>17</i>
2.3.14	<i>Info</i>	<i>18</i>
2.4	ADVANCED FUNCTIONS.....	19
2.4.1	<i>Manual COM Port Selection.....</i>	<i>19</i>
2.4.2	<i>Load Saved Log Files.....</i>	<i>19</i>
2.4.3	<i>Error Code of Continuous Log Files.....</i>	<i>19</i>
2.5	TROUBLESHOOTING.....	19
2.5.1	<i>Startup Errors.....</i>	<i>20</i>
2.5.2	<i>Hardware State</i>	<i>20</i>
2.5.3	<i>Port Connection Problems.....</i>	<i>20</i>
2.5.4	<i>Measurement Info Messages.....</i>	<i>21</i>
2.5.5	<i>Application, Sensor and File State.....</i>	<i>21</i>
3	HALLINSIGHT® SENSOR MODULES	22
3.1	32X2 PIXEL LINE ARRAY (LINE ARRAY 64 PIXELS).....	22
3.2	16X16 PIXEL PLANE ARRAY (PLANE ARRAY 512 PIXELS)	23
3.3	32X32 PIXEL PLANE ARRAY (PLANE ARRAY 1024 PIXELS)	24
4	TECHNICAL CHARACTERISTICS	25
4.1	OPERATING CONDITIONS.....	25
4.2	MAGNETIC SPECIFICATIONS	25
5	GEOMETRIC SENSOR DETAILS.....	26

1

Basic Information

This document contains all necessary information on operating a HallinSight® Magnetic Measurement System including software installation, software operation, operating conditions and technical details.

Even if it was composed to the best of one's knowledge it cannot be guaranteed that all specifications are correct. Therefore, all information is specified as subject to change as well as errors and omissions are excepted.

For possibilities of user specific adaptations of the HallinSight® Technology and further information please visit www.iis.fraunhofer.de/hallinsight

1.1

System Requirements

For proper operation of the HallinSight® Magnetic Measurement System please make sure to fulfil the minimum system requirements of your computer as follows:

- Compatible operating systems:
 - ✓ Windows 7 (32bit or 64bit)
 - ✓ Windows 10 (32bit or 64bit)
- Hardware requirements:
 - USB 2.0 or higher
 - Dual-core processor with 2 GHz or higher
 - Minimum 2 GB internal RAM
 - Monitor with screen resolution of at least 1280 x 800
 - Recommended: Dedicated GPU

1.2

Operating Conditions

The HallinSight® Magnetic Measurement System was designed for indoor use in laboratories and under moderate conditions. It is not designed for outdoor use or rough conditions. The magnetic sensors are calibrated for use within an ambient temperature range from 10 °C to 30 °C. As the sensors heat up during measurement, the sensor temperature should not exceed 55 °C. If the sensors are operated outside this range you a temperature warning is displayed because the best metering precision cannot be guaranteed.

Please note that 3D-printed parts of the camera housing of some systems are only approved for temperatures up to 60 °C.

1.3

Customer Support

For questions and troubleshooting please contact the customer support:

Email: contacts@metrolab.com, phone: +41 (0)22 884 33 11

2 Software Description

2.1 Software Installation

The HallinSight® GUI software for visualization, analysis and logging of the measurement values is based on the development platform National Instruments LabVIEW. For using the software, the corresponding LabVIEW runtime-libraries and drivers are automatically installed during the installation process.

The software was developed for the use with Windows 7 or Windows 10 operating systems; it cannot be guaranteed that the software is properly working under other versions.

2.1.1 USB Driver Installation

When connecting the HallinSight® System to the PC for the first time the driver for the USB interface has to be installed. Since it is a common serial port driver many systems are providing a suitable driver (virtual COM port). Please check if the driver has installed successfully in Windows Device Manager on your PC (*WIN+R: devmgmt.msc -> Ports (COM & LPT)*). You should find a new entry called "USB Serial Device". If there is no device visible, please see 2.5.3 for troubleshooting.

2.1.2 GUI Software Installation

The software for visualization, analysis and logging of the measurement values is based on the development platform National Instruments LabVIEW. During execution of the delivered HallinSight_GUI_Installer.exe, all needed runtime libraries and drivers are installed. Please follow the steps through the installation process.

After successful installation, shortcuts to the program executable are available in the program menu and on the desktop.

2.2 Software Start

Before starting the HallinSight® GUI software, make sure the HallinSight measurement hardware is supplied with 5 V from the delivered supply and connected to the PC with a suitable USB cable.

For launching the software just double click on one of the "HallinSight_GUI" shortcuts in the program menu or on the desktop.

After execution the HallinSight GUI software starts and initializes the connected hardware automatically. If an error occurs during startup, a related message will appear. If you have trouble during startup, please see section

For manual starting the GUI software, press the arrow symbol below the menu bar.

2.3.1 General Information

The **Graphical User Interface** of the HallinSight® System provides different visualization plots and analysis tools to view and evaluate the magnetic field that percolates the measurement area of the HallinSight® sensor module.

The sensor modules are capable of physically measuring all three magnetic field components B_x , B_y and B_z , together composing the magnitude of the magnetic field $B_{abs} = \sqrt{B_x^2 + B_y^2 + B_z^2}$. From these components, further parameter to characterize the magnetic field are calculated.

The Cartesian coordinates B_x , B_y and B_z can be transferred into a spherical coordinate system, composed of the three parameters *Radius*, *Azimuth* and *Inclination*:

- Radius: The Radius is equal to the field's magnitude $Radius = B_{abs}$
- Azimuth: The azimuthal angle Φ is calculated from the relation of B_y to B_x :
$$\Phi = \arctan\left(\frac{B_y}{B_x}\right)$$
- Inclination: The polar angle Θ is calculated from the relation B_z to *Radius*:
$$\Theta = \arccos\left(\frac{B_z}{\sqrt{B_x^2 + B_y^2 + B_z^2}}\right)$$

In addition to the three Cartesian components B_x , B_y and B_z also their derivatives to the three geometric dimensions x , y and z are calculated. This way the field gradient of the measurement result can be visualized and analyzed. Due to Maxwell's equations some derivatives are equal to each other and thus not calculated separately:

- B_x/dx : Geometric derivation from B_x to x : $\frac{dB_x}{dx}$
- B_y/dx : Geometric derivation from B_y to x : $\frac{dB_y}{dx} = \frac{dB_x}{dy}$
- B_y/dy : Geometric derivation from B_y to y : $\frac{dB_y}{dy}$
- B_z/dx : Geometric derivation from B_z to x : $\frac{dB_z}{dx} = \frac{dB_x}{dz}$
- B_z/dy : Geometric derivation from B_z to y : $\frac{dB_z}{dy} = \frac{dB_y}{dz}$
- B_z/dz : Geometric derivation from B_z to z : $\frac{dB_z}{dz}$

2.3.2 Context Help

All control and indication elements of the GUI software provide a context help for supportive tips that is shown when the mouse is hovered over the element. For activation please press *Ctrl + H* or select over the application menu: *Help -> Show Context Help*.

2.3.3 GUI header

The GUI Software is composed of a header area with multiple measurement controls and indicators and a tab selector for different visualization plots and analysis tools of the magnetic measurement.

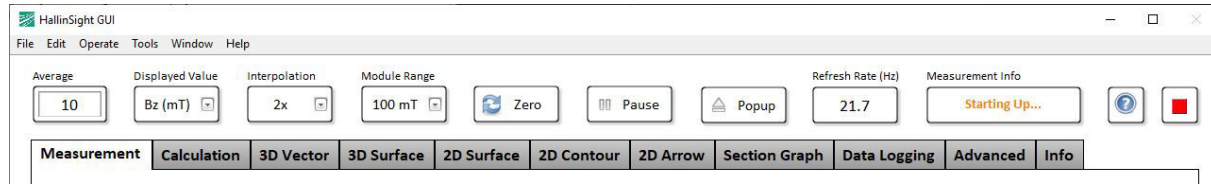

Different controls for adjusting the magnetic measurement are available:

- **Average:** Arithmetic mean over the selected number of measurements. Averaging will slow down the measurement rate of the sensor module. If an average value of 0 (zero) is entered, a single log file can be imported.
- **Displayed Value:** Selects the measured or calculated value for visualization and analysis. See chapter 2.3.1 for detailed description of those values.
 - Bx (mT): x component of magnetic field vector in millitesla
 - By (mT): y component of magnetic field vector in millitesla
 - Bz (mT): z component of magnetic field vector in millitesla
 - Babs (mT): magnitude of magnetic field vector in in millitesla
 - Phi (deg): azimuthal angle of magnetic field vector in degree
 - Theta (deg): polar angle of magnetic field vector in degree
 - Bx/dx (mT/mm): derivation from Bx to x in millitesla per millimeter
 - By/dx (mT/mm): derivation from By to x in millitesla per millimeter
 - By/dy (mT/mm): derivation from By to y in millitesla per millimeter
 - Bz/dx (mT/mm): derivation from Bz to x in millitesla per millimeter
 - Bz/dy (mT/mm): derivation from Bz to y in millitesla per millimeter
 - Bz/dz (mT/mm): derivation from Bz to z in millitesla per millimeter
- **Interpolation:** Performs a cubic spline interpolation between the native sensor positions to increase the geometric measurement resolution by selected factor
- **Module Range:** Switch between available measurement ranges (+/- range). Adapt the measurement range to the expected magnetic field during runtime.
- **Zero:** Prompts the software to subtract the current measurement from all following measurements (should be used to zero remaining sensor offsets)
- **Pause:** Pauses software execution and holds the current measurement
- **Popup:** Opens additional window with currently active plot
- **Refresh Rate:** Refresh rate of selected visualization or analysis tab
- **Measurement Info:** Message windows for occurring errors. Also see 2.5.4.
- **Help:** Opens this PDF manual
- **Stop:** Stops software execution

The tab *Measurement* contains numeric indicators of the current magnetic measurement result. The results either can be viewed at a specified position or as statistical values over the complete measurement area.



Measurement Values at specified XY-Position in Measurement Area

This section shows the results of Bx, By, Bz and Babs at a specified position. The desired XY-position has to be defined in the first two fields (*X-Position (mm)* and *Y-Position (mm)*). Because of the geometric limited measurement resolution the nearest X and Y positions are determined and shown in *Nearest X (mm)* and *Nearest Y (mm)*. The geometric resolution can be increased with *Interpolation*. The resulting position in the measurement area is showed as a yellow dot in the plot "*Position in Array*" in the bottom left corner. The plot background shows the selected "*Displayed Value*". The geometric coordinate system of the sensor module is defined in 3.

If you want to specify an arbitrary point in the measurement area that is not mapped to the nearest position, please see the functionality *Point* of the analysis tool *Section Graph* described in 2.3.11.

Measurement Statistics of Array

This section shows minimum and maximum values of all results in the measurement area as well as the mean value. With the button *Hold Min/Max* the extreme values are hold in memory as long as the button is activated.

Temperature Statistics of Array

This section shows minimum and maximum temperature values of the sensors in the measurement area as well as the mean value of the complete array and the all-time maximum value since application start in *Hold Max (°C)*.

2.3.5 Calculation

The tab *Calculation* contains numeric indicators of the calculated parameter for special coordinates and field gradient from the current magnetic measurement result. To understand how the parameter are calculated, please see 2.3.1. The results either can be viewed at a specified position or as statistical values over the complete measurement area.

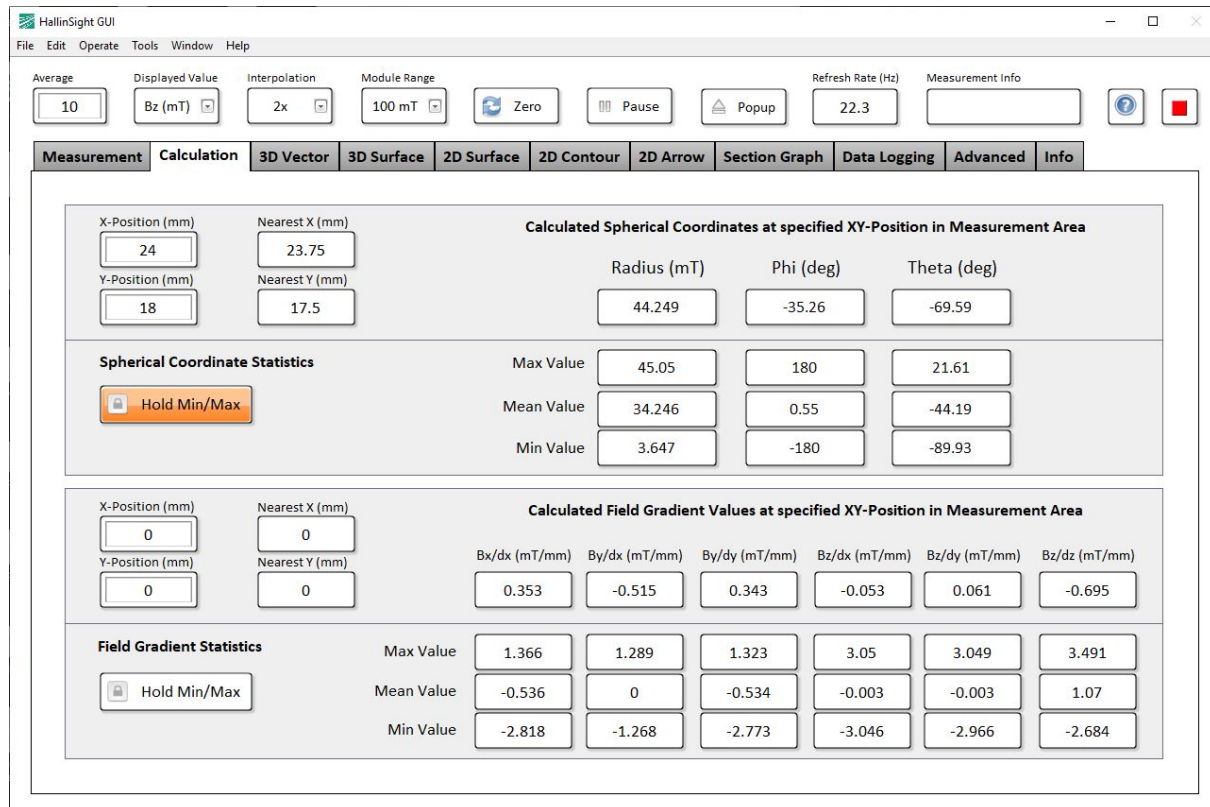

Calculated Spherical Coordinates at specified XY-Position in Measurement Area

This section shows the results of Radius, Phi and Theta at a specified position. The desired XY-position has to be defined in the first two fields (*X-Position (mm)* and *Y-Position (mm)*). Because of the geometric limited measurement resolution the nearest X and Y positions are determined and shown in *Nearest X (mm)* and *Nearest Y (mm)*. The geometric resolution can be increased with *Interpolation*.

Calculated Field Gradient Values at specified XY-Position in Measurement Area

This section shows the results of the derivatives of Bx, By and Bz at a specified position. The desired XY-position has to be defined in the first two fields (*X-Position (mm)* and *Y-Position (mm)*). Because of the geometric limited measurement resolution the nearest X and Y positions are determined and shown in *Nearest X (mm)* and *Nearest Y (mm)*. The geometric resolution can be increased with *Interpolation*.

Spherical Coordinates Statistics and Field Gradient Statistics

In these sections minimum and maximum values of the calculated parameter in the measurement area as well as the mean value are shown. With the button *Hold Min/Max* the extreme values are hold in memory as long as the button is activated.

2.3.6 3D Vector Plot

The tab *Vector Plot* shows a three dimensional vector plot of all three magnetic field components as arrows. The magnitude of the field is applied to the color of the arrows, in which green stands for the weakest field and red for the strongest field. Together the complete magnetic information of the measured field is shown in this plot. *Displayed Value* has no effect on this plot. Every arrow shows the measurement of a single magnetic sensor and thus the geometric resolution cannot be changed. With the button *Popup*, a second window with the currently active settings of the plot is opened.

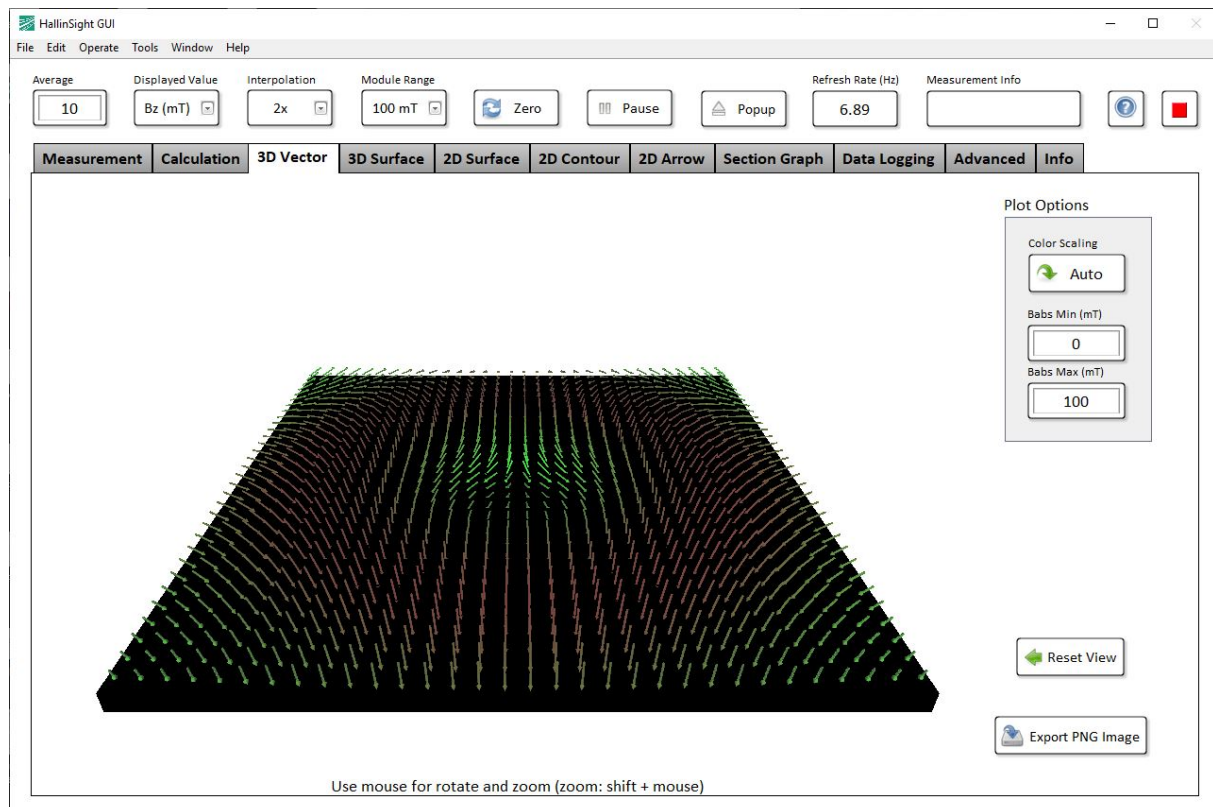

Plot Options

The *Color Scaling* of the arrows can be switched between *Auto* and *Fixed*. In *Auto* mode, the minimum and maximum value of the magnitude of the measured field is applied. In *Fixed* mode, the upper and lower limits of the scale are defined by the controls *Bmin (mT)* and *Bmax (mT)*.

The view of the plot can be manipulated with the mouse. To reset the view to default, press the button *Reset View*.

A PNG image of the plot can be exported with the button *Export PNG Image*. Therefore, a file dialogue is opened.

2.3.7 3D Surface Plot

The tab *3D Surface Plot* shows a three dimensional surface plot of the measurement result that can be modified with the controls in the header section. *Displayed Value* controls the value that is plotted against the Z-axis of the plot. The geometric resolution in X- and Y direction can be increased with *Interpolation*. With the button *Popup*, a second window with the currently active settings of the plot is opened.

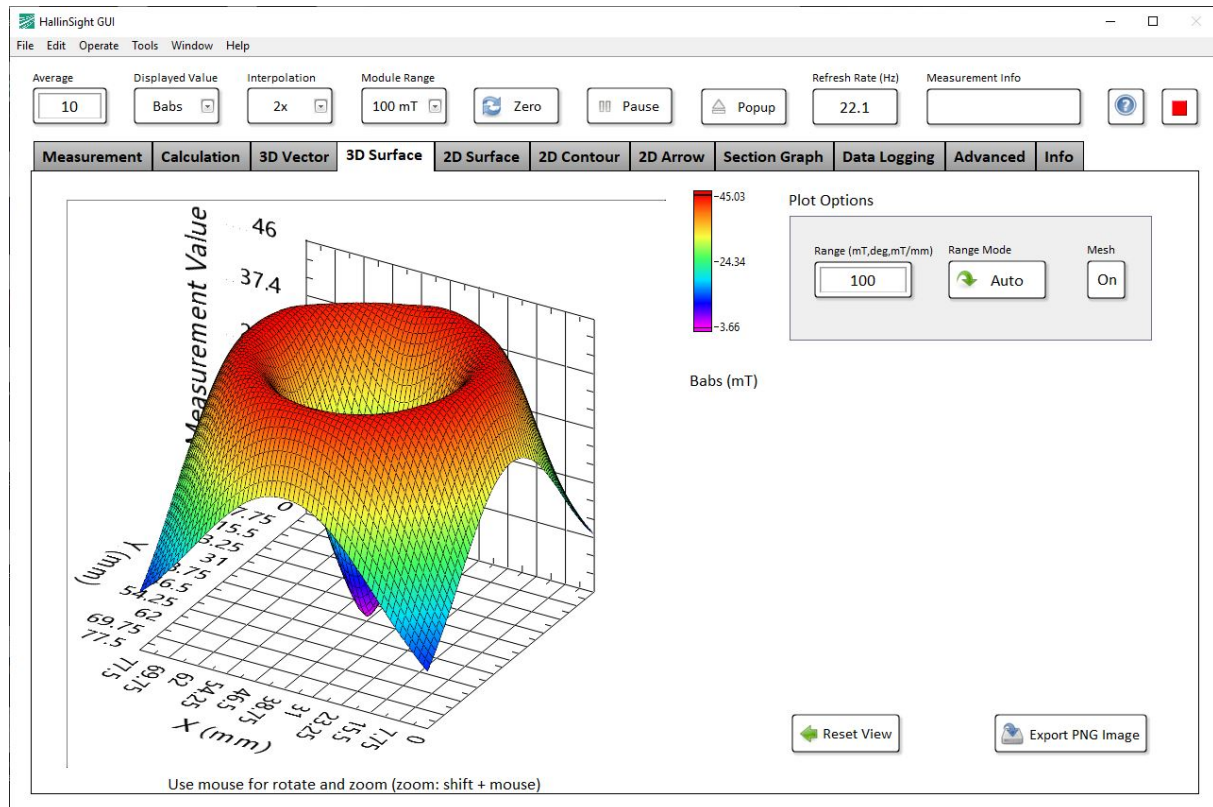

Plot Options

The range of the Z-axis can be adapted with the control *Range (mT,deg,mT/mm)* and changed from fixed range to auto range with the button *Range Mode* on the right. The mesh overlaid to the surface plot can be turned on and off with the button *Mesh*.

The view of the plot can be manipulated with the mouse. To reset the view to default, press the button *Reset View*.

A PNG image of the plot can be exported with the button *Export PNG Image*. Therefore, a file dialogue is opened.

2.3.8 2D Surface Plot

The tab *2D Surface Plot* shows a two dimensional surface plot of the measurement result that can be modified with the controls in the header section. *Displayed Value* controls the value that is plotted with the related color spectrum. The geometric resolution in X- and Y direction can be increased with *Interpolation*. With the button *Popup*, a second window with the currently active settings of the plot is opened.

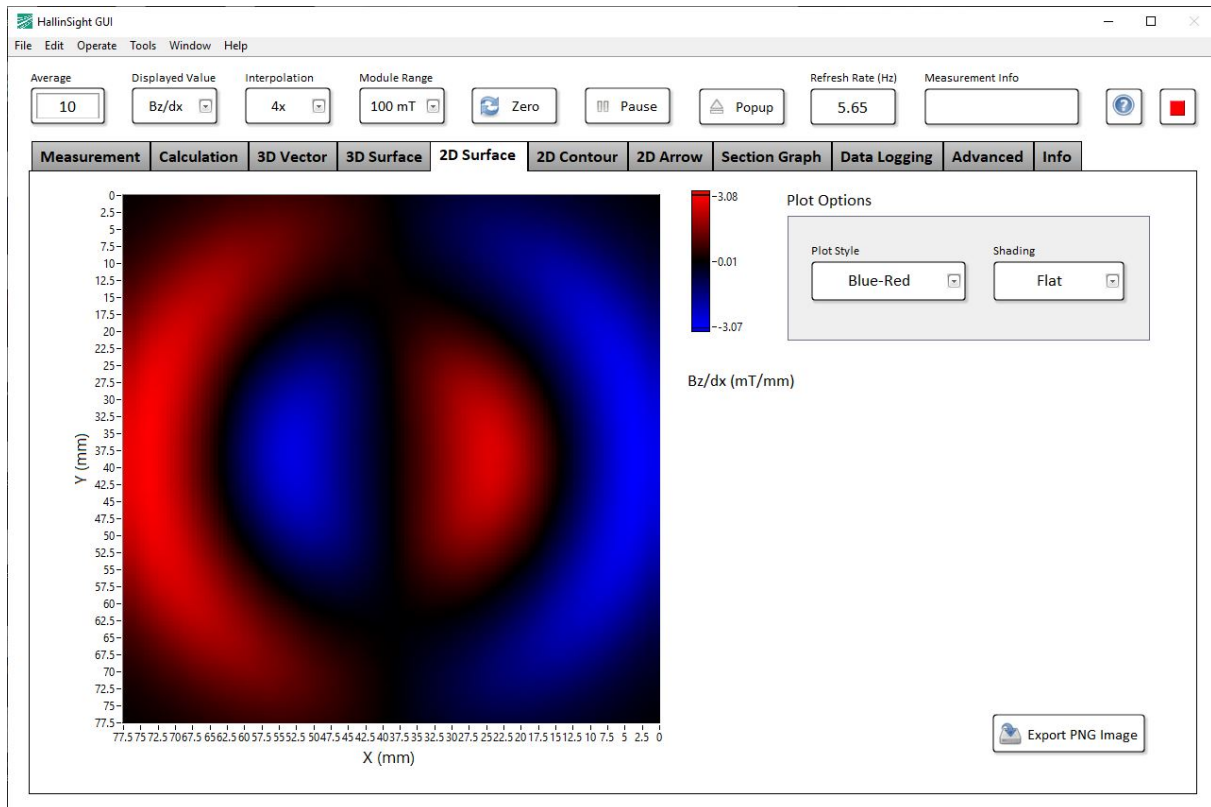

Plot Options

The color scheme of the plot can be modified with *Plot Style*. There are multiple presets to choose from. With the selector *Shading*, the color spectrum can be flattened or interpolated.

A PNG image of the plot can be exported with the button *Export PNG Image*. Therefore, a file dialogue is opened.

2.3.9 2D Contour Plot

The tab *2D Contour Plot* shows a two dimensional contour plot of the measurement result that can be modified with the controls in the header section. *Displayed Value* controls the value that is plotted with the related color spectrum. The geometric resolution in X- and Y direction can be increased with *Interpolation*. With the button *Popup*, a second window with the currently active settings of the plot is opened.

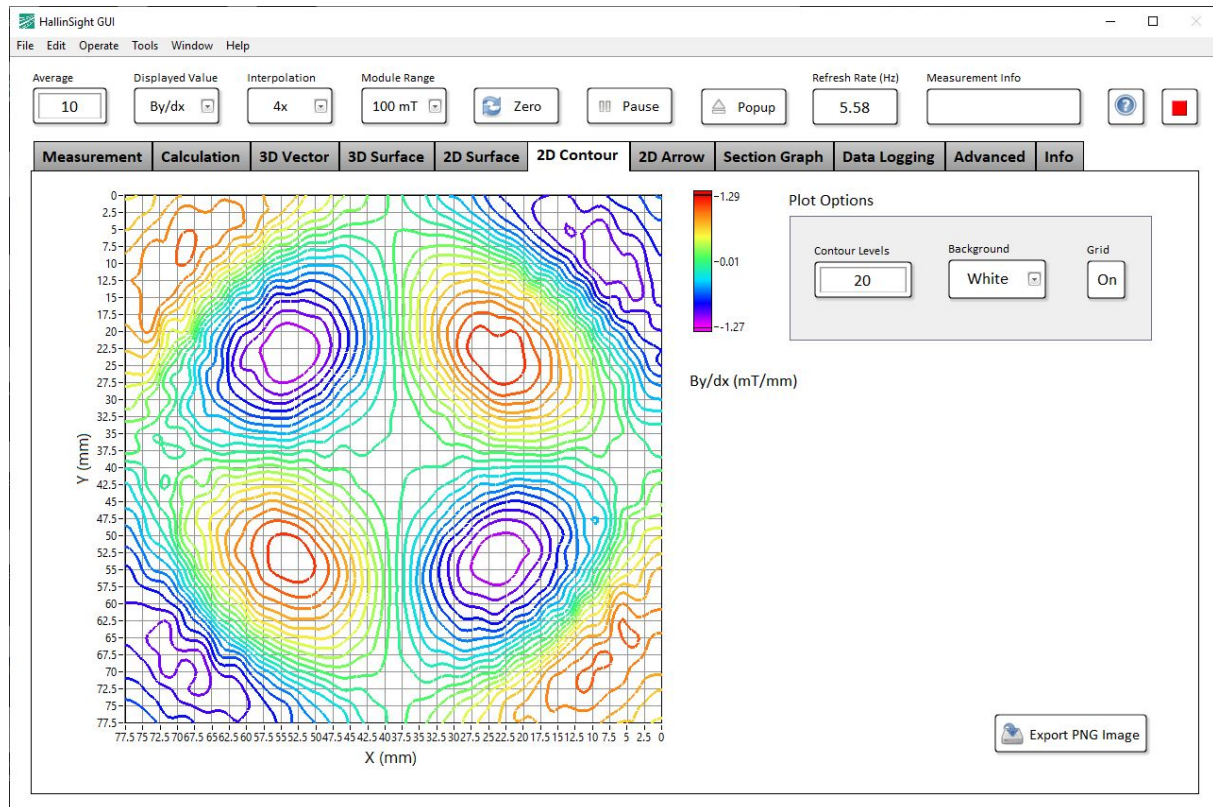

Plot Options

The number of plotted contours can be adjusted with the control *Contour Levels*. The valid range goes from 1 to 255. The selector *Background* can be used to change the background color of the plot. The shown grid that is equal to the sensor positions can be switched on an off with the button *Grid*.

A PNG image of the plot can be exported with the button *Export PNG Image*. Therefore, a file dialogue is opened.

2.3.10 2D Arrow Plot

The tab *2D Arrow Plot* shows a vector plot of two in-plane magnetic field components as arrows. The measurement result that can be modified with the controls in the header section. *Displayed Value* controls the value that is plotted with the related color spectrum. Every arrow shows the measurement of a single magnetic sensor and thus the geometric resolution cannot be changed. With the button *Popup*, a second window with the currently active settings of the plot is opened.

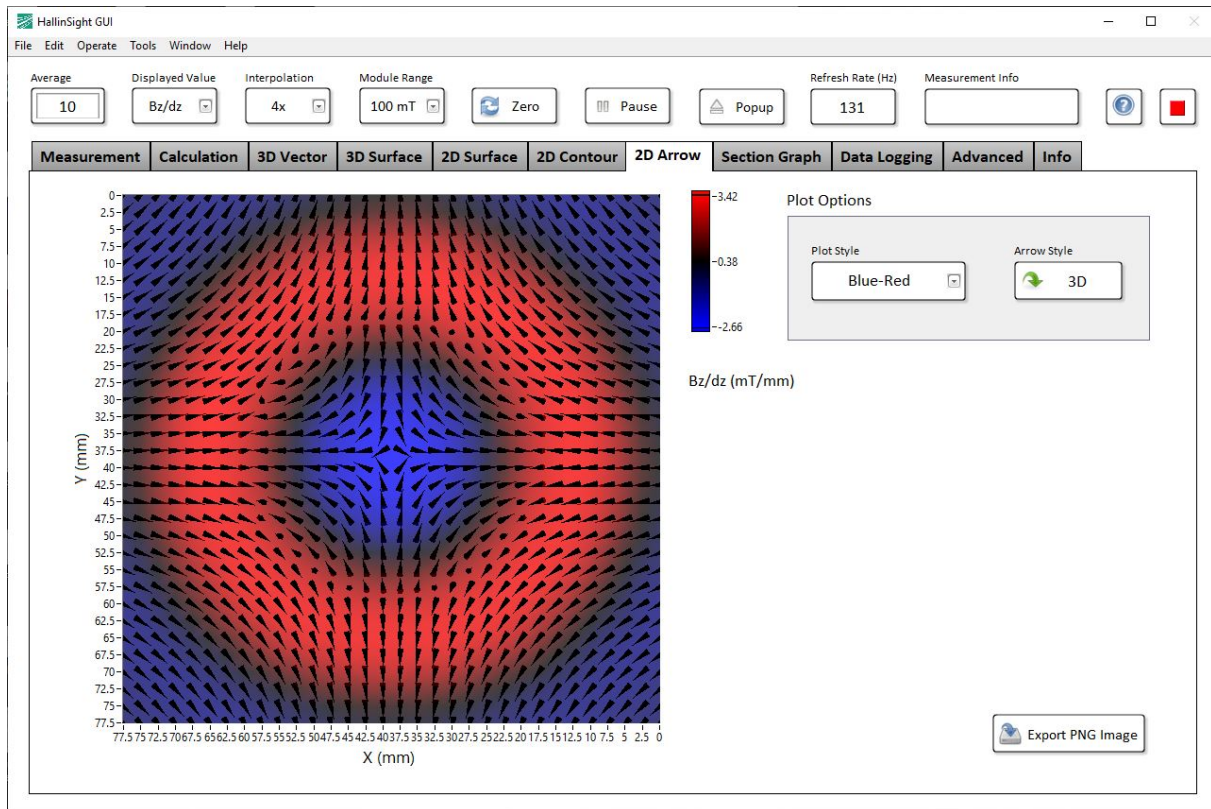

Plot Options

The background of the plot can be changed to different color schemes and as well be turned off with *Plot Style*. The style of the arrows can be toggled between 3D and 2D with the button *Arrow Style*. In 3D mode, the perpendicular component of the arrow is scaled with *Babs*.

A PNG image of the plot can be exported with the button *Export PNG Image*. Therefore, a file dialogue is opened.

2.3.11 Section Graphs

The tab *Section Graph* allows to plot a defined value along a specified graph within the measurement area. *Displayed Value* controls the value that is plotted along the section. Different types of sections can be defined and are plotted as yellow graph together with the *Displayed Value* in a 2D surface plot.

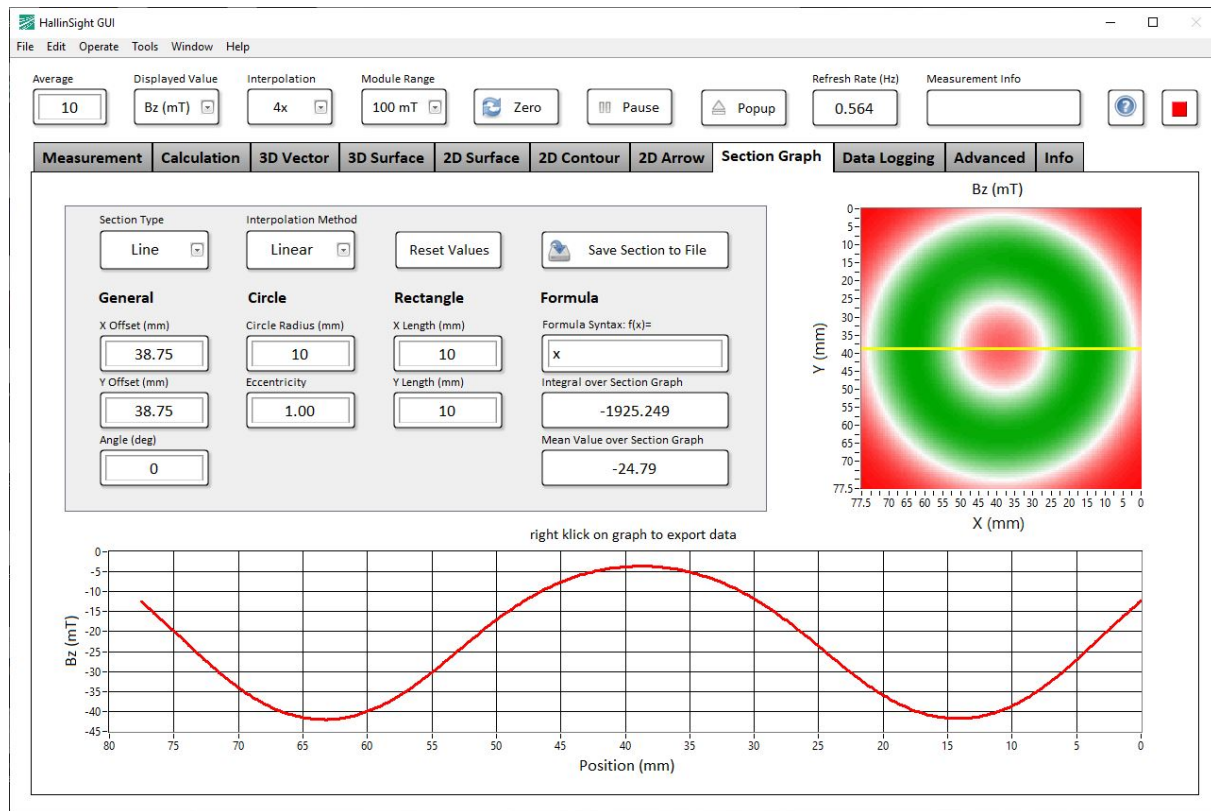

Plot Options

With the selector *Section Type* different presets of sections are selectable: *Line*, *Circle*, *Rectangle*, *Point* and *Formula*. *Line* defines a straight through the measurement area. *Circle* and *Rectangle* define geometric graphs in clockwise direction, starting from $X=0$ and $+Y$ for *Circle* and $-X$ & $-Y$ for *Rectangle*. *Point* allows to select an arbitrary point in the measurement area. *Formula* allows the user to define a formula string in *Formula syntax* $f(x)=$. Examples are: $\sin(x)+10$, $((x-20)*0.5)^2+10$, $\exp(10/x)+20$

Geometric parameter of the graphs can be changed with the options below. *General* parameter offset and angle affect all sections except *Formula*. For *Circle* and *Rectangle* particular options are available to change radius, eccentricity, X- and Y lengths.

To get smoother results, the section can be interpolated using different methods with the selector *Interpolation Method*. Do not use this interpolation together with high grades of global *Interpolation*, as it leads to very high memory usage and might result in an application crash. Recommended: *Interpolation 4x*, *Method: linear*

The indicators *Integral over Section Graph* and *Mean Value over Section Graph* show integrated value (Simpson's rule) and mean value over all interpolated values along the section graph. Thus, in *Point* mode the mean value shows the value at this point.

With the button *Reset Values*, all options are reset to default state.

The active section graph can be saved to a file with *Save Section to File*. The graph plot in the below section can be exported with different options via right click on the plot.

2.3.12 Data Logging

The tab *Data Logging* allows the user to log the measurement values to a specified file. Three different log methods are available for logging data once and continuously or transfer data to another application. File paths and extensions can be specified freely.

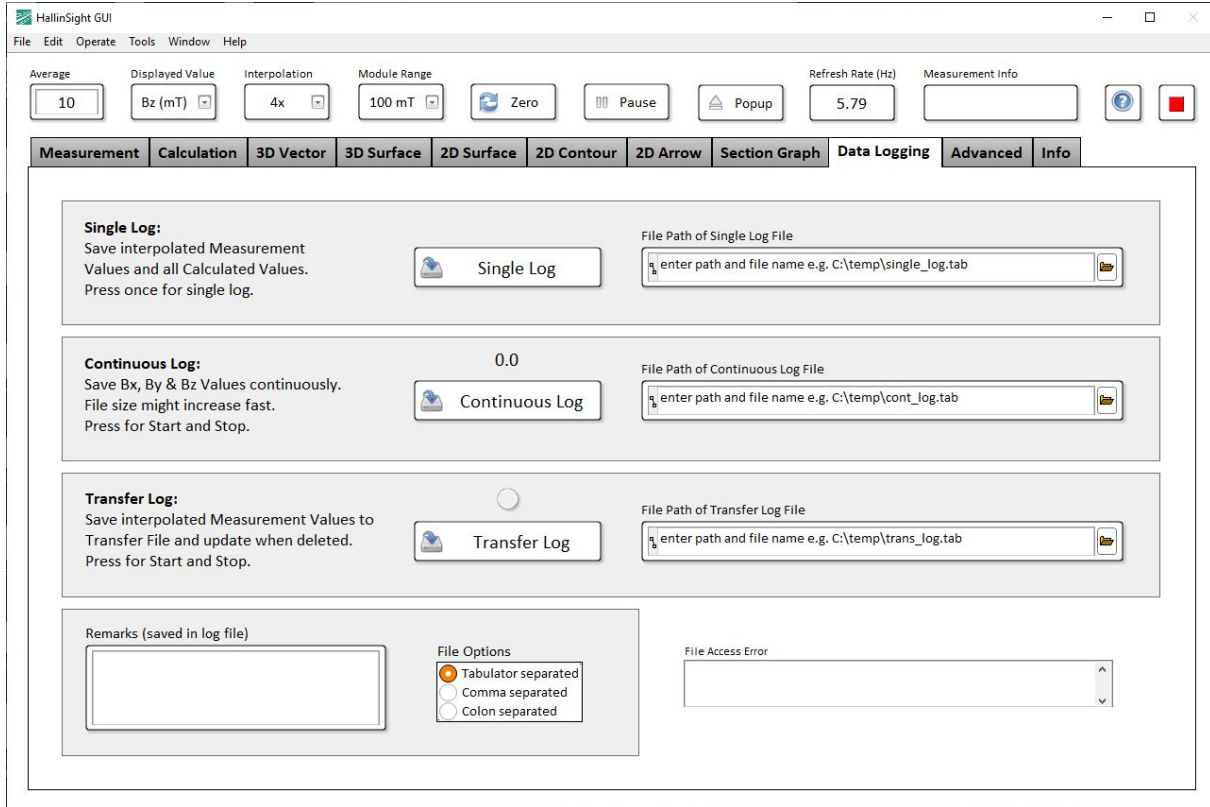

Single Log: The single log saves all measurement and calculated data to a file as it is shown in the visualization and analysis tabs. Data are saved with set *Interpolation* and *Zero* function. The measurement is saved once when the *Single Log* button is pressed.

Continuous Log: With continuous logging the raw measurement data of all sensors are saved to a file continuously as long as the log button is activated. For fast saving no interpolation and no calculation of additional parameter is applied to the magnetic measurement result. New results are attached to the end of the file with a timestamp of the internal timer and an error code signaling occurring errors during measurement (see 2.4.3). The size of the log file might increase fast depending on the measurement rate. Continuous logging is started and stopped with the *Continuous Log* button, whereas the numerical indicator on top of the button shows the elapsed time.

Transfer Log: The transfer log function saves the same data as single log to the specified file. As soon as the file is deleted from another application, it is created with updated measurement data again. Transfer logging is started and stopped with the *Transfer Log* button. The indicator on top of the button changes to orange when the transfer log file is available.

In the field *Remarks* the user can insert measurement related comments that are saved in the header of each measurement file. The radio button selector *File Options* allows the user to choose the separator type of each log file. The separator selection is also applied to the *Save Section to File* function (see 2.3.11). Occurring errors during file access are shown in the indicator "*File Access Error*".

2.3.13 Advanced

The tab *Advanced* provides additional functionality for specific requirements. The user can save and load reference files and is able to activate a transient mode for time dependent measurement plots.

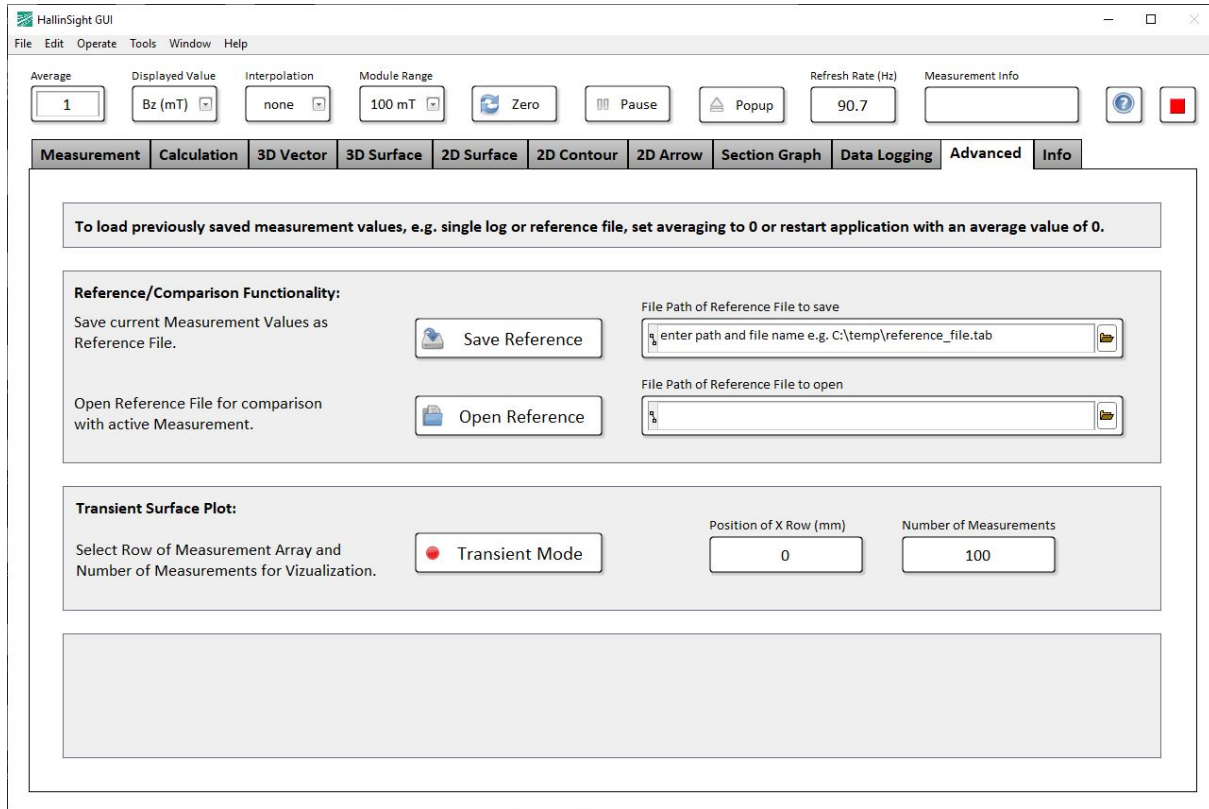

Reference/Comparison Functionality: This functionality allows for saving and opening reference measurement files. The opened measurement file is subtracted from the current measurement and allows comparison with older measurements. The reference measurement is saved once when the *Save Reference* button is pressed. File paths and extensions can be specified freely.

Transient Surface Plot: The button *Transient Mode* enables time dependent visualization for the surface plots. Therefore, a row of the measurement array is selected with *Position of X Row (mm)* and with *Number of Measurements* the length of the transient visualization is defined. Recording can be stopped with *Pause*. Most functions of the surface plots can be used also in transient mode, but there are few restrictions: *Popup* function, *3D vector plot* and *transfer log option* are disabled. Also, *calculation and visualization of geometric deviations* is not possible in transient mode.

2.3.14 Info

The tab *Info* provides additional information about the connected HallinSight® System and indicators regarding the application's state. In case of errors during operation this tab should be used for troubleshooting.

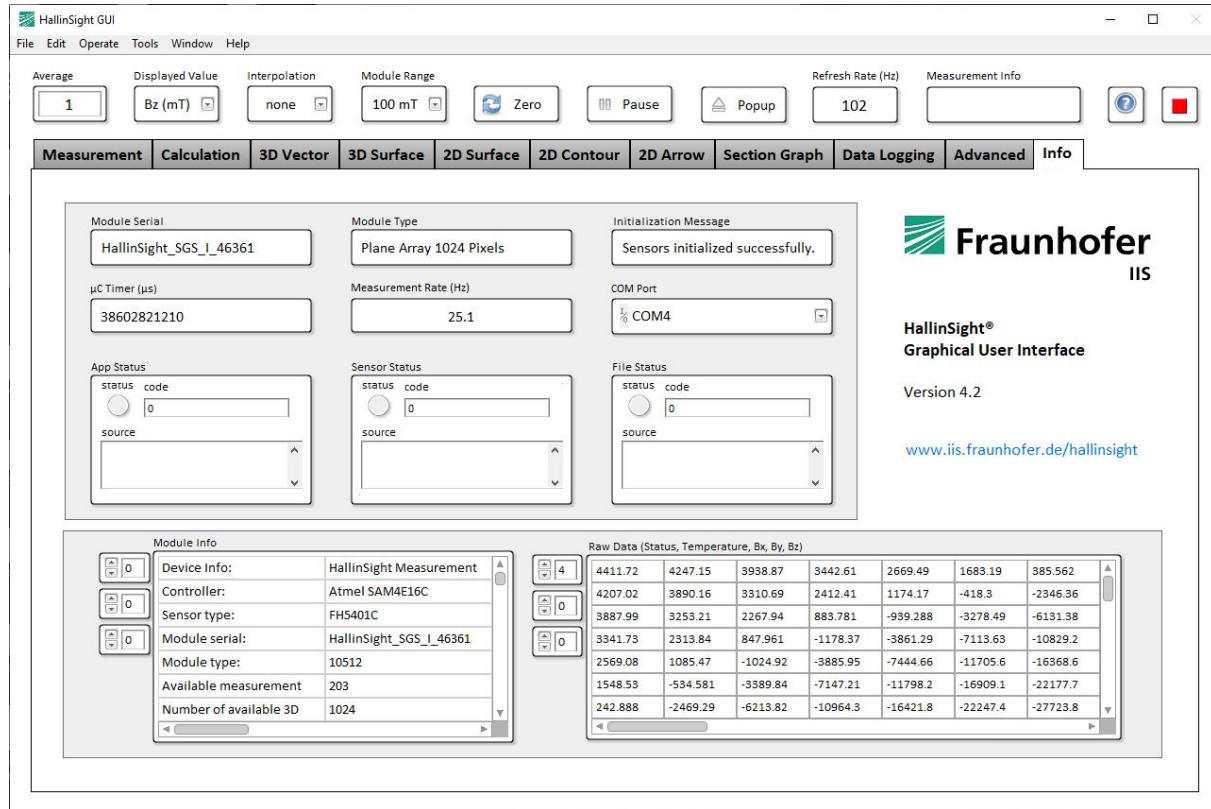

Indicators:

Module Serial shows the serial of the connected HallinSight sensor module.

Module Type shows the type of the recognized connected HallinSight sensor module.

Initialization Message shows the answer of the HallinSight system during startup.

μC Timer (μs) shows the internal timer value of the system's microcontroller.

Measurement Rate (Hz) shows the derived measurement rate from the μC Timer. The rate decreases proportionally to the selected averaging value.

COM Port shows the port at which the HallinSight system was found or which port the application should use (also see 2.4.1). Clicking the arrow shows available COM ports.

App, Sensor and File Status are indicators for occurring warning and error messages (see 2.5.5 for further details).

Module Info shows the complete module information of the connected HallinSight system as well as serial numbers and geometric position of the sensors.

Raw Data is a three dimensional array showing raw measurement data of all sensors as a two dimensional matrix. With the top numerical control the indicated data can be selected (Order: status, temperature in °C, followed by the three magnetic components in micro Tesla: Bx, By, Bz).

2.4 Advanced Functions

2.4.1 Manual COM Port Selection

In case the HallinSight System is not found at the right COM Port automatically, it is possible to select a static COM Port in the field *COM Port* in the *Info* tab before starting the application. This way it is also possible to use multiple systems on the same PC at different COM Ports.

2.4.2 Load Saved Log Files

It is possible to load previously saved Single Log Files to visualize and analyze the measurement data with the GUI Software again. Two methods to load the saved Log File are available:

- During application execution: When the application is running, the average value has to be set to 0 (zero). A dialogue for loading an existing file is started. After loading the saved data the application is set in pause mode. Quitting the pause mode resets the application to normal execution.
- Before application start: Before execution of the application is started, the average value has to be set to 0 (zero). A dialogue for loading an existing file is started. After loading the saved data the application is set to pause mode. Execution can be stopped by quitting the pause mode or stopping the application. For normal operation set an average value unequal 0.

2.4.3 Error Code of Continuous Log Files

During *Continuous Log* measurement sensor errors might occur. Therefore for every measurement of a sensor an error code is saved. If the code is equal to 0, the measurement was performed without errors. Every deviation indicates an error that can be treated for the individual sensor that delivered the error. The error code is composed of several error bits and has to be interpreted bitwise:

<i>Error Code (binary)</i>	<i>Error Name</i>	<i>Description</i>	<i>Recommended Action</i>
0	No error	Measurement ok	-
1	Ready error	Sensor decimation faulty: Measurement not finished yet	Discard measurement result
10	Temperature warning	Sensor temperature out of limits (15°C – 55°C)	Keep temperature within limits
100	Range warning	Sensor ADC overflow: Sensor signal out of range	Discard result and change <i>Module Range</i>
1000	Normalizing warning	Sensor normalizing overflow: Error during sensor post processing	Discard measurement result
10000	Overflow warning	Sensor sensitivity overflow: Sensitivity correction out of range	Discard measurement result

Examples

Code (b00000010): Temperature Warning

Code (b00011001): Combined Ready, Normalizing and Overflow Error

The temperature flag should be monitored if maximum metering precision is needed.

2.5 Troubleshooting

If there are problems during startup or operation of the HallinSight GUI Software, please check this chapter for troubleshooting.

2.5.1 Startup Errors

During startup the GUI Software automatically scans the COM Ports of the PC for a connected HallinSight System. If no system is found following message is shown: “*No HallinSight Measurement System found! Please connect suitable measurement hardware*”.

Please check if power supply is plugged in and working (2.5.2) and if the USB connection is established (2.5.3). After that the HallinSight System is initialized. If an error occurs during initialization, following message is shown:

Error during initialization: No response from sensor module. Please reconnect HallinSight System and restart application!

In this case please check the *Initialization Message* in the tab *Info (2.3.13)* for further details on the error.

If the HallinSight system is found and initialized correctly, no further error messages are shown and the GUI software is starting up.

2.5.2 Hardware State

The state of the HallinSight Measurement System is indicated with multiple signal LEDs. These are mounted inside the camera housing and can be seen from the outside.

Three signal LEDs indicate the state of the controller operating system.

One LED is toggled every second to indicate that the operating system is running. If this LED is not blinking you should reconnect the power supply to reset the system or use the reset button. A second static LEDs show that the measurement system is in ready state. The third LED is glowing as long as a measurement is active. A red LED is the indicator for errors. If the red LED is active the sensor module is defective or an error during communication with the connected sensors has occurred. In this case please reconnect the power supply to reset the sensor module or press the reset button.

2.5.3 Port Connection Problems

The GUI Software automatically scans the COM Ports of the PC for a connected HallinSight System. In case the GUI Software cannot find the HallinSight System, check if the system is found in the ports of your PC's device manager:

(WIN+R: *devmgmt.msc* -> “*Ports (COM & LPT)*”). The system should be listed as “*USB Serial Device*”. If no system is present in the list, please reconnect the system to the PC and observe if a new device is registered from the PC.

It might be necessary to manually install a driver for a new device or an unknown device. Therefore, please follow the driver installation dialogue and manually specify the driver location in the folder “*driver\atmel_devices_cdc*” in the folder of the HallinSight GUI Installer.

It is also possible to specify a fixed COM Port the GUI software has to use. Therefore please see 2.4.1.

2.5.4 Measurement Info Messages

The *Measurement Info* indicator in the header area shows status and warning messages. Warning and error messages can be send from the application or from one or multiple magnetic field sensors.

See following table for possible messages and their meaning:

<i>Message</i>	<i>Class</i>	<i>Meaning</i>	<i>Action</i>
Starting Up...	Application	Startup routine is in progress	none
Loading Log File...	File	Load log file dialogue active	finish dialogue
Log File Loaded	Application	Log file is loaded in GUI	Press <i>Pause</i> to stop
Zero measurement...	Application	Zero measurement in progress	Press <i>Zero</i> to disable
Continuous Log...	File	Continuous log in progress	Press <i>Continuous Log</i> to stop
Ready Error!	Sensor	Sensor decimation faulty: Measurement not finished yet	Discard measurement result
Temperature Warning!	Sensor	Sensor temperature out of limits (15°C – 55°C)	Keep temperature within limits
Range Warning!	Sensor	Sensor ADC overflow: Sensor signal out of range	Discard result and change <i>Module Range</i>
Normalization Overflow!	Sensor	Sensor normalizing overflow: Error during sensor post processing	Discard measurement result
Sensitivity Overflow!	Sensor	Sensor sensitivity overflow: Sensitivity correction out of range	Discard measurement result

Sporadic warnings of the sensors are not uncommon do not need to be investigated. If messages or errors of the sensors are displayed permanently, stop the application and reset the sensor module.

2.5.5 Application, Sensor and File State

If the application is not working properly or even crashes the indicators *App*, *Sensor* and *File Status* in the tab *Info* should contain warning or error messages that help with continuative troubleshooting. Please note that these warnings and errors are created from the LabVIEW environment and are best investigated online.

3 HallinSight® Sensor Modules

Different HallinSight® Sensor Modules are available. Hardware geometrics, coordinate systems and technical features are specified below. All geometric measures are in *mm*; coordinate systems (CS) are right-handed (order: x-y-z).

3.1 32x2 Pixel Line Array (Line Array 64 Pixels)

The sensor spacing in X- and Y-direction is 2.5 mm . The measuring distance in Z-direction is given by the sensor package and amounts about $360\text{ }\mu\text{m}$ (see chapter 5).

The 32x2 HallinSight Pixel Line Array is delivered without a case for flexible integration in systems. The PCB provides mounting holes for fixation in customer applications. For dimensions of PCB and mounting see following drawings (all dimensions in *mm*).

This HallinSight system is split in two parts: The PCB containing sensors, and the interface box that is connected to the sensor PCB with a ribbon cable and provides the USB connector for power supply and communication.

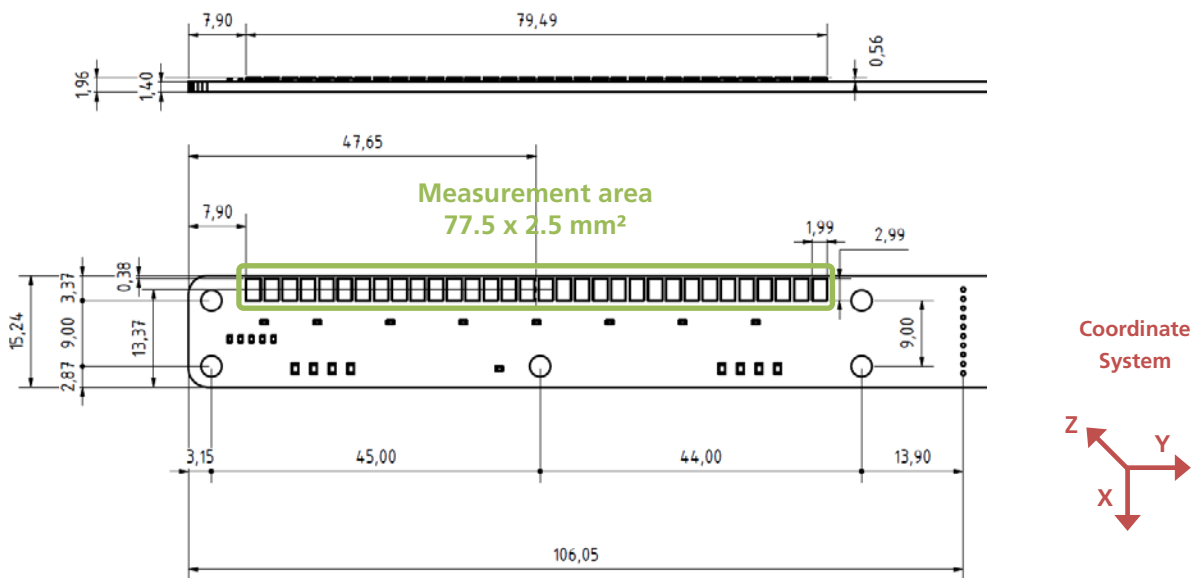

Interface box:

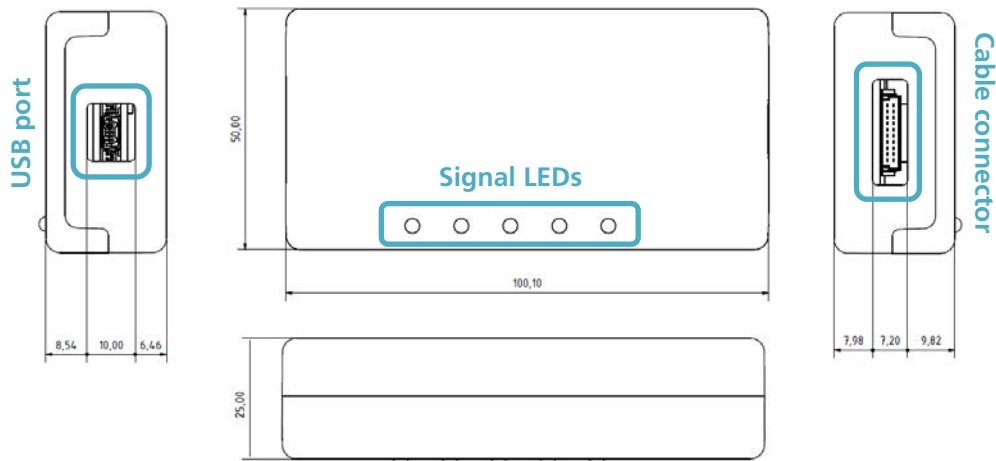

3.2

16x16 Pixel Plane Array (Plane Array 512 Pixels)

The sensor spacing in X- and Y-direction is 2.5 mm. Measuring distance in Z-direction (distance between active sensor and case) is also 2.5 mm.

The 16x16 HallinSight Pixel Array is delivered with an aluminum case. The case provides mounting holes for integration in customer applications. For dimensions of case and mounting see following drawings (all dimensions in mm).

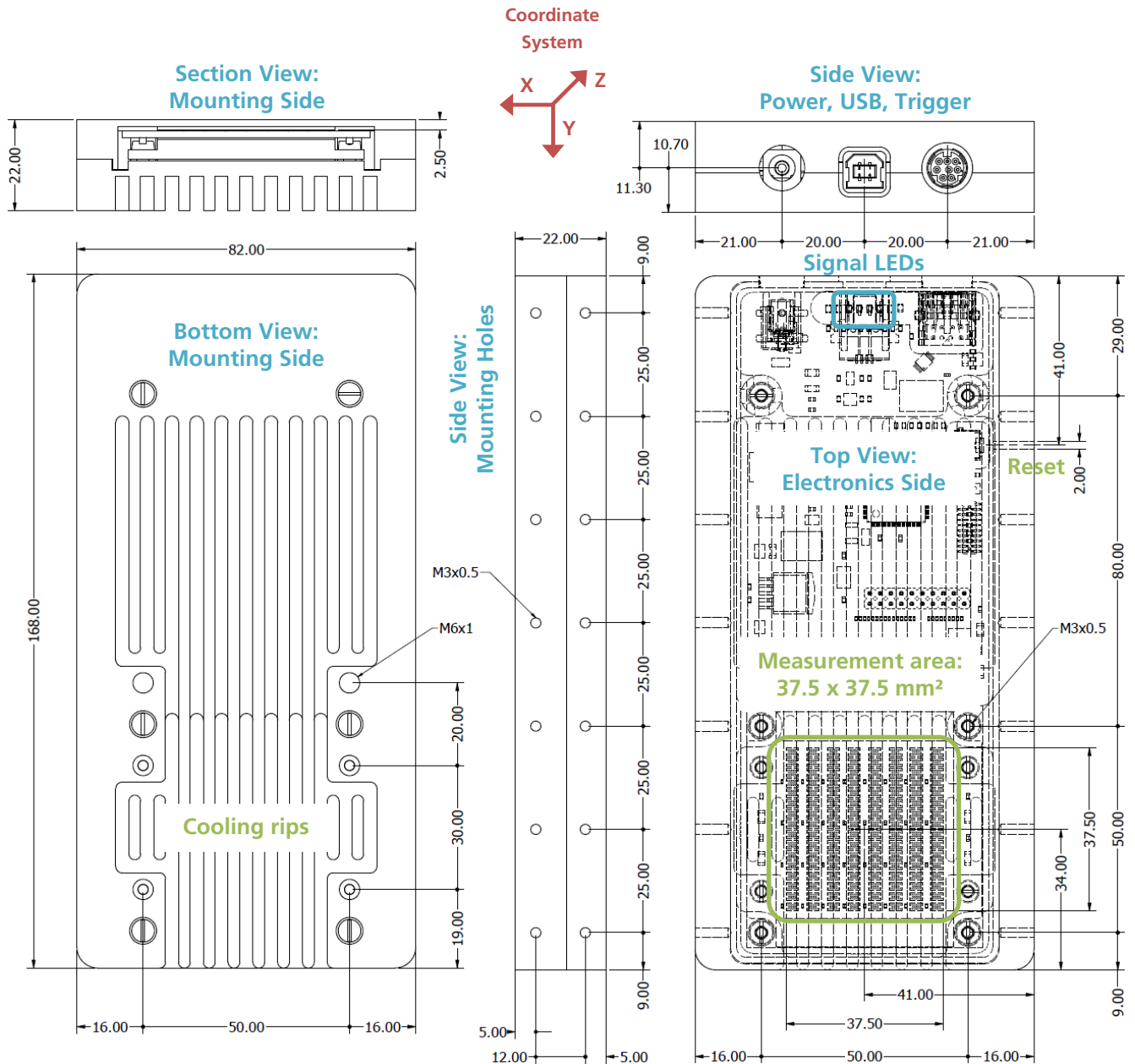

3.3

32x32 Pixel Plane Array (Plane Array 1024 Pixels)

The sensor spacing in X- and Y-direction is 2.5 mm. Measuring distance in Z-direction (distance between active sensor and case) is also 2.5 mm.

The 32x32 HallinSight Pixel Array is delivered with an aluminum case. The case provides mounting holes for integration in customer applications. For dimensions of case and mounting see following drawings (all dimensions in mm).

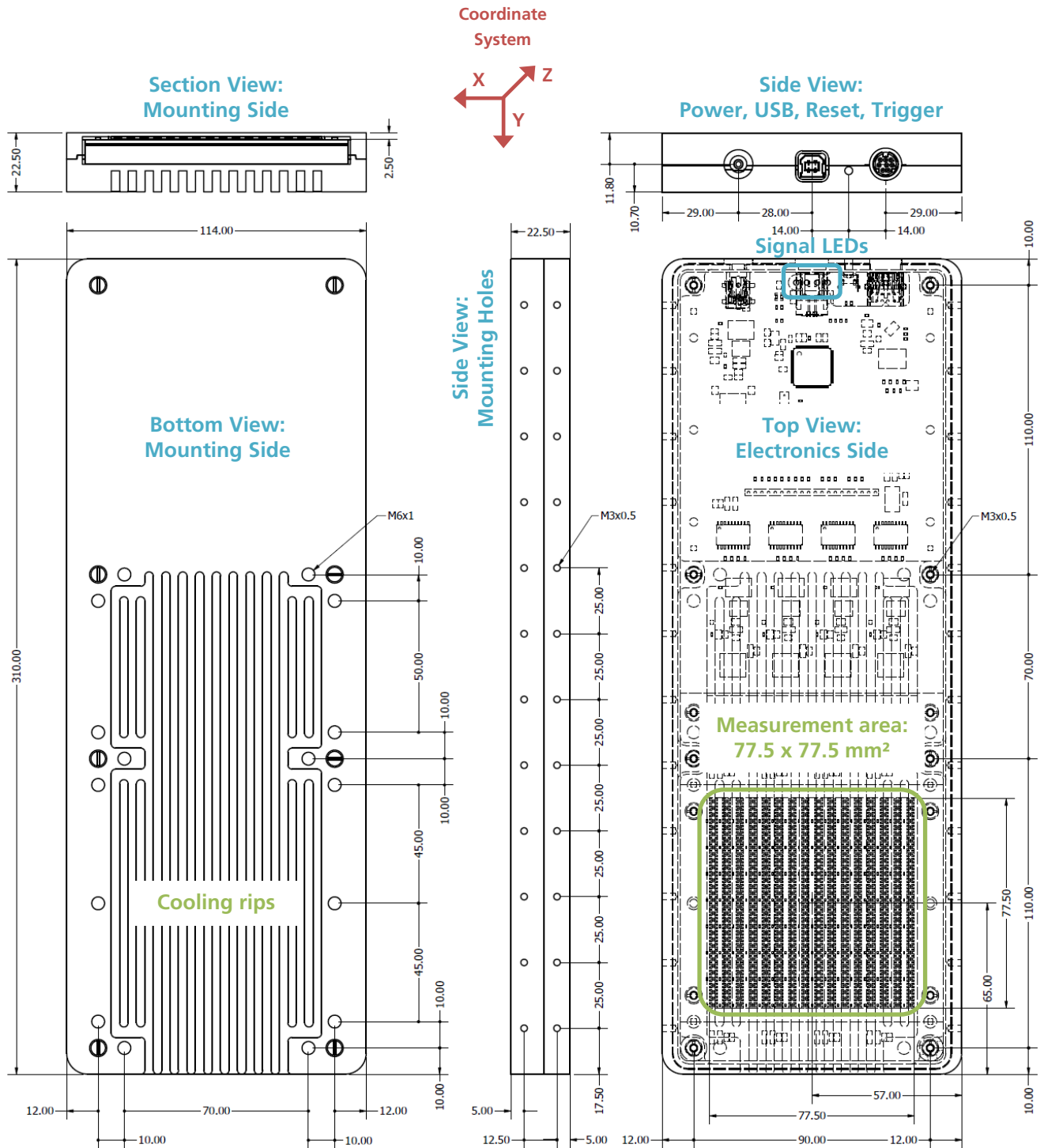

4 Technical Characteristics

4.1 Operating Conditions

Parameter	Value	Unit	Note
Operating Temperature	10 - 30	°C	ambient
Global Power Supply	5	V	max. 6
USB Power Supply (USB 2.0)	5	V	max. 5.25
Supply Voltage of Sensors	3.3	V	max. 3.6
Current Consumption per Sensor	10	mA	max. 15
Trigger In/Out Level	3.3	V	max. 5

4.2 Magnetic Specifications

All HallinSight® Magnetic Measurement Systems are fully calibrated in a magnetic reference field. The following characteristics are valid for the standard configuration of the sensors with a metering range of 100 mT. Magnetic resolution, noise and offset are directly related to metering range and scale with lower or greater ranges. All specifications are valid for operation in ambient temperature range.

Parameter	Value	Unit	Note
Magnetic Resolution	4	μT	no avg.
Magnetic Accuracy	0.1	%	typ.
Magnetic Offset	25	μT	typ.
Magnetic Remanence	<1	μT	typ.
Magnetic Noise	25	μT	RMS
Measurement Integration Time	2	ms	no avg.
Sensor Lateral Position Error on PCB	<50	μm	typ.
Sensor Vertical Position Error on PCB	<10	μm	typ.
Sensor Rotational Position Error on PCB	<0.1	°	corrected

**Technical
Specifications**

5 Geometric Sensor Details

The actual sensitive area is located on the bottom side of the soldered IC. The circuit board thickness is highly variable depending on the system. In contrast, the chip thickness has very low tolerance.

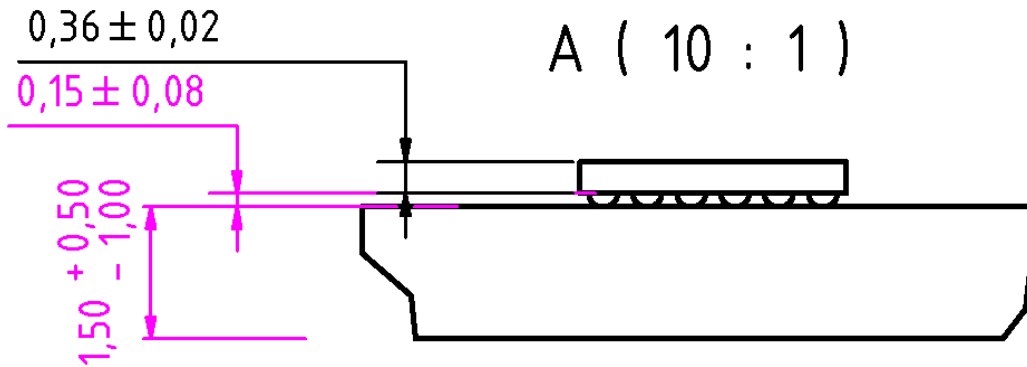

Every FH5401c sensor contains two 3-D Hall sensors (pixels) for vectorial measurement of magnetic fields. Geometrical dimensions of the sensor and the position of the actual sensitive sensor area can be extracted from following figure and table.

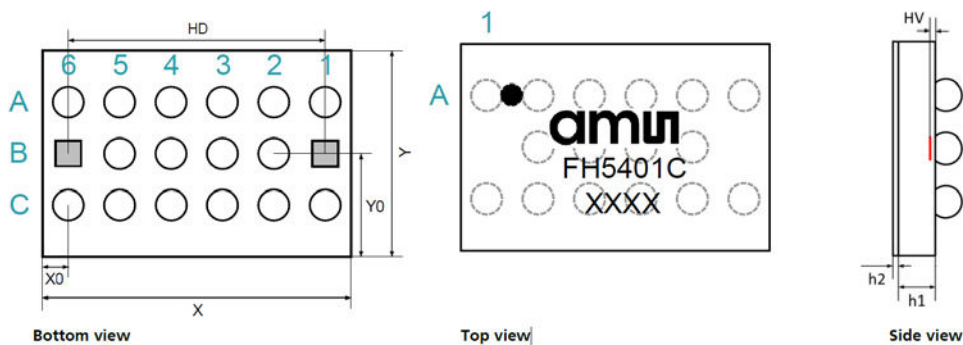

Parameter	Symbol	Typ	Unit
Chip Length	X	3035	μm
Chip Width	Y	2035	μm
Hall Sensor Distance	HD	2500	μm
x-Distance Edge-Sensor	X ₀	285	μm
y-Distance Edge-Sensor	Y ₀	1035	μm
Hall Sensor Vertical	HV	30	μm
Total Chip Thickness	h ₁ + h ₂	360	μm

Geometric Specifications